

Вариант 1

□ ткань 1

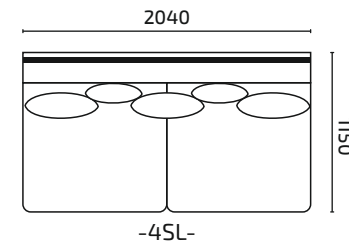
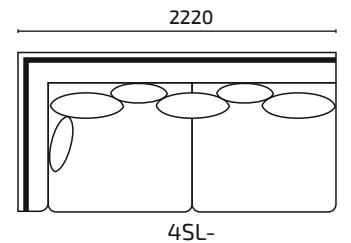
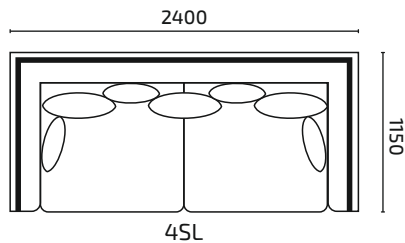
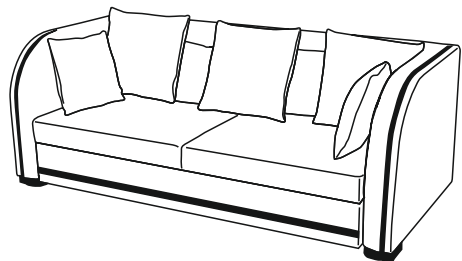

Вариант 2

□ ткань 1

▣ ткань 2

■ ткань 3

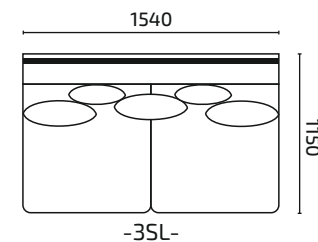
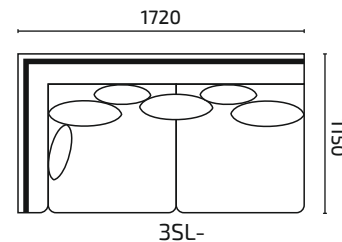
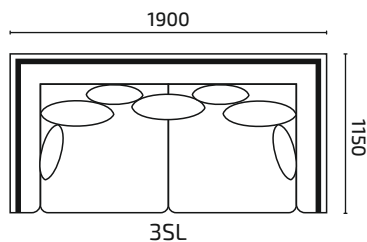
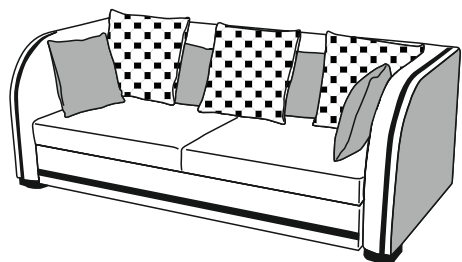

Вариант 3

□ ткань 1

■ ткань 2

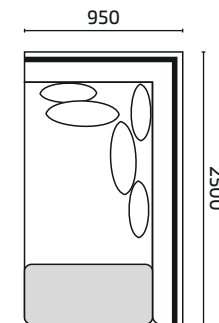
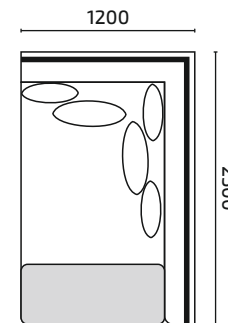
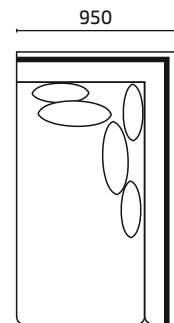
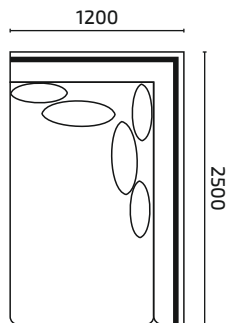
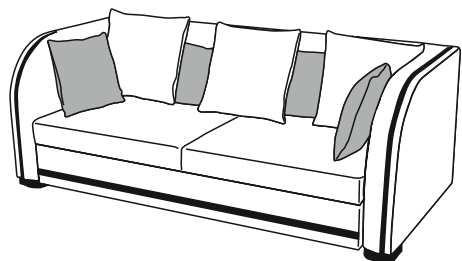

Вариант 4

□ ткань 1

▣ ткань 2

■ ткань 3

■ ткань 4

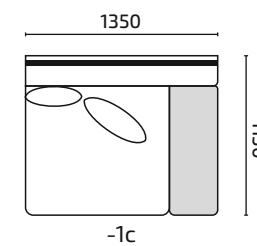
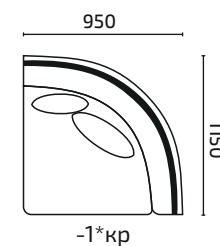
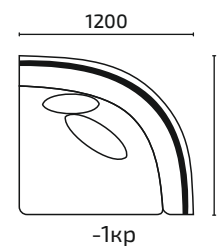
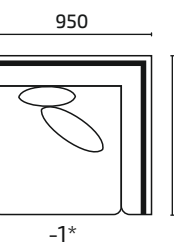
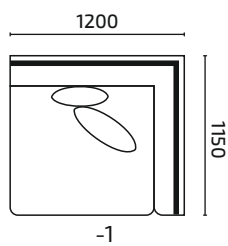
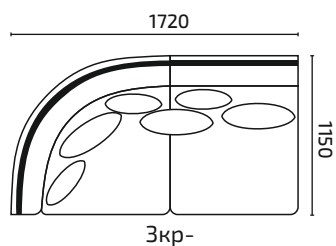
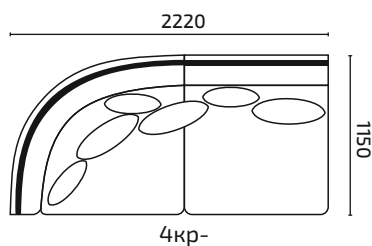
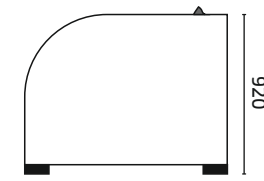
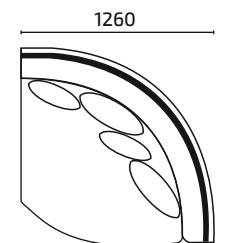
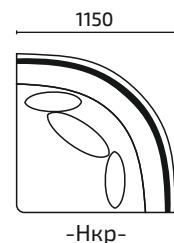
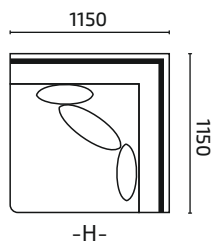

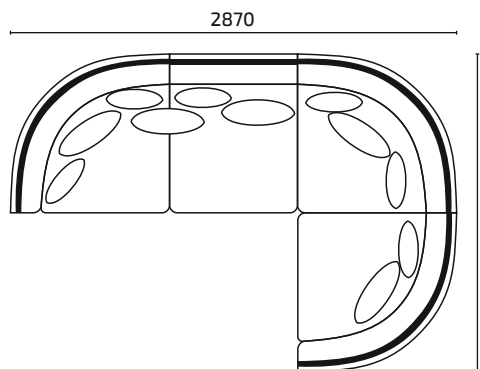

3кр-Нкр-1*кр

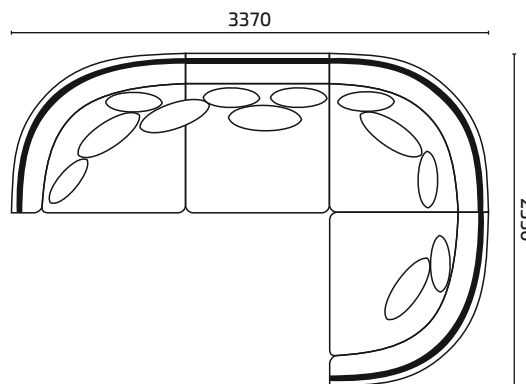

4кр-Нкр-1кр

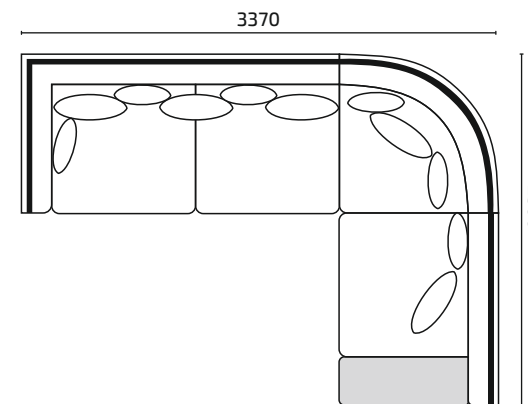

4SL-Нкр-1с

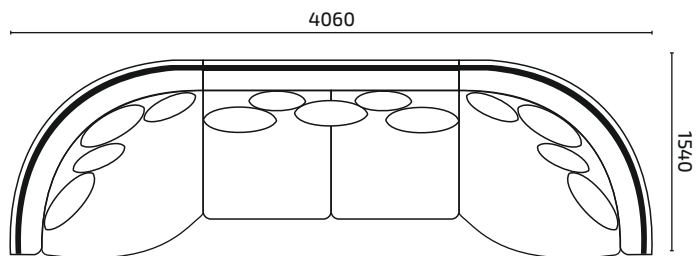

Л-3SL-Л

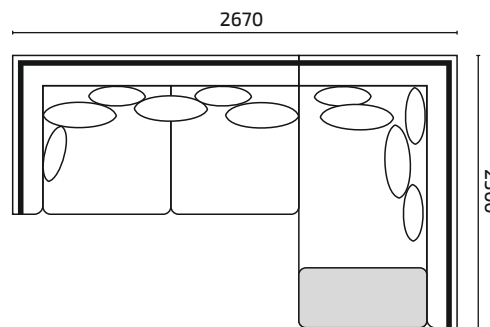

3SL-Пуф*МС

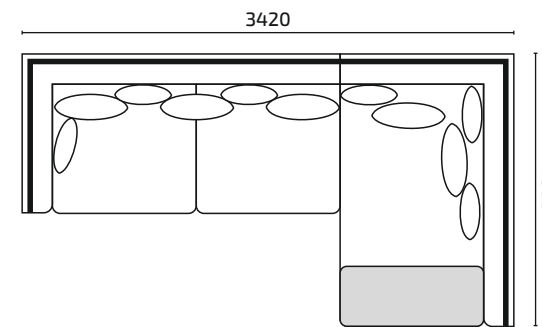

4SL-ПуфМС

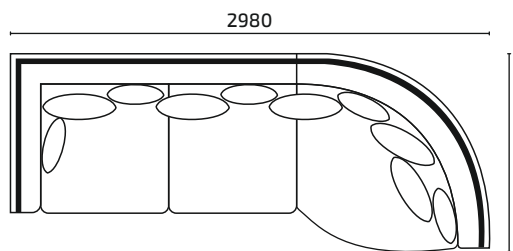

3SL-Л

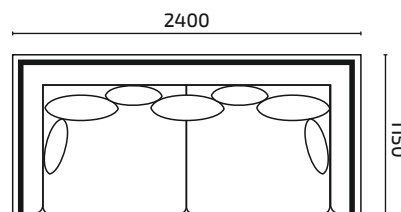

4SL

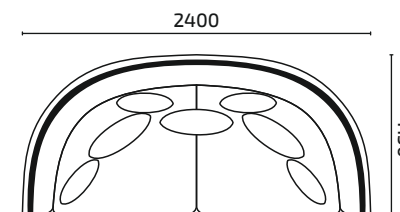

4кр

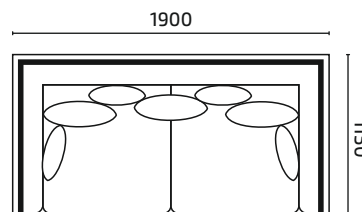

3SL

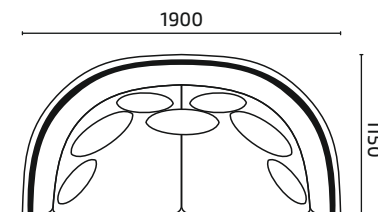

3кр